

~*A Toy for Daisy*~

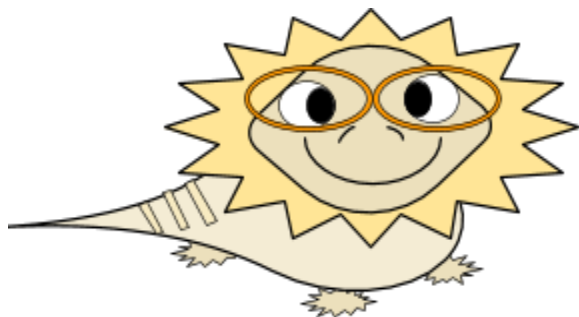

Meet Darwin. Darwin is a bearded dragon who loves to pose for pictures. He is also a scientist and an engineer who loves to conduct experiments and help solve problems!



Today, Darwin decided to go and visit his good friend Daisy. Daisy is usually an exuberantly happy young pup who loves to give lots of kisses and is always wanting to play!!



But this day when Darwin saw Daisy, she looked like she was a little down...



"What's wrong Daisy? You look a little sad today."

"Hi Darwin. Thanks for visiting me! I am feeling a little sad because I love to play fetch but all my friends and family have been too busy or tired to play with me everyday."

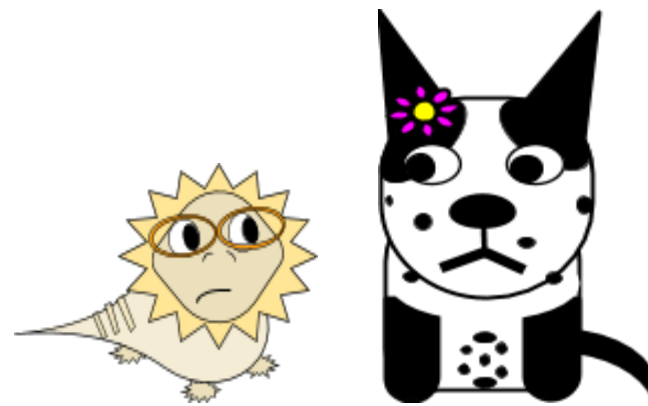

"I'm sorry to hear that but being the scientist/engineer that I am, I think might be able to help make you something that can solve your problem...!"

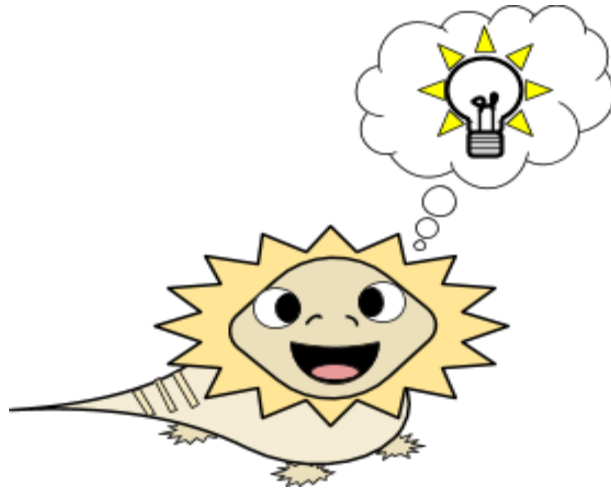

Can YOU think of a toy that Daisy could use to play fetch with herself...?

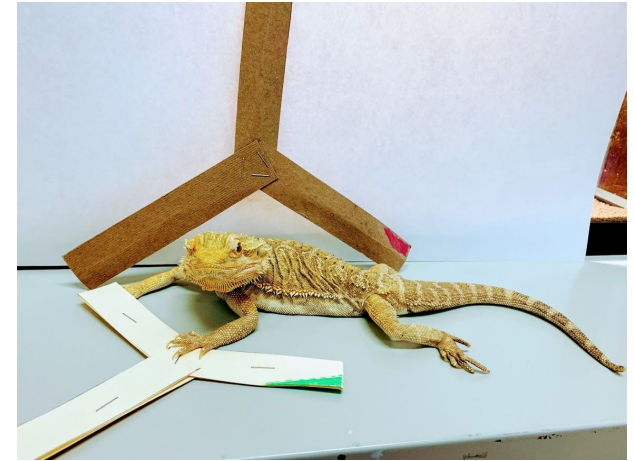
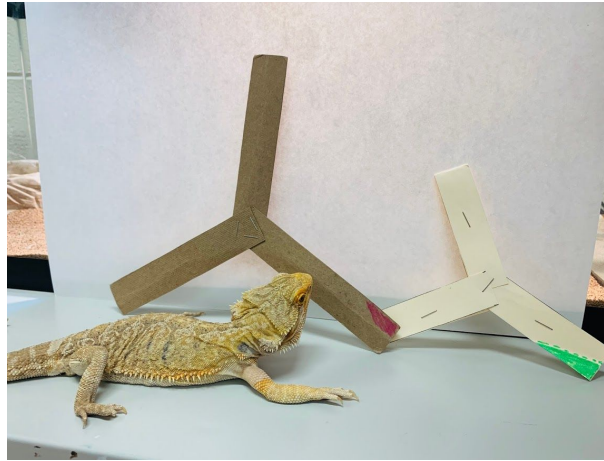
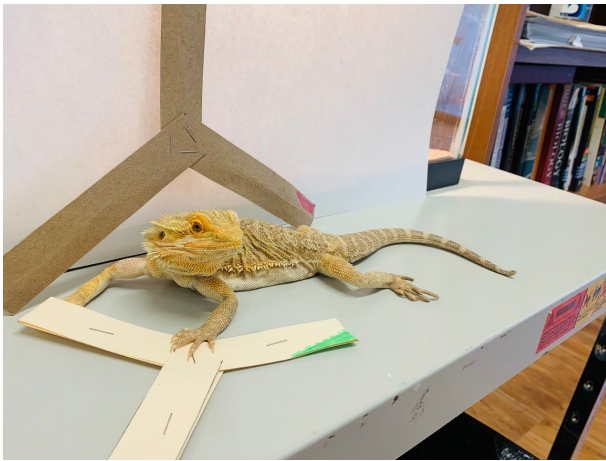

How to make your very own “Play-Fetch-By-Yourself” Boomerang!!!

*Materials:

-Ruler
-Writing Utensil
-Cardboard Sheet, at least 4" x 6" large -
(cardboard can be the kind from standard cardboard shipping box, cereal box, shoe box, etc...)

-Scissors
-Stapler
OR if cardboard is not readily available, can also consider substituting with file folders or cardstock but you may need to double layer these alternatives in order to get the ideal thickness/stiffness...

*Instructions:

1. Cut out 3 equal strips of cardboard - (1" x 6").

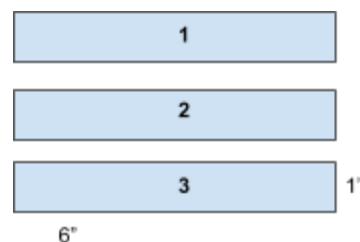

2. Staple 2 strips together at 120° angle in a V-shape.

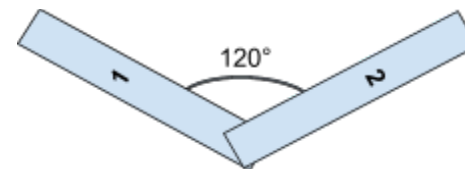

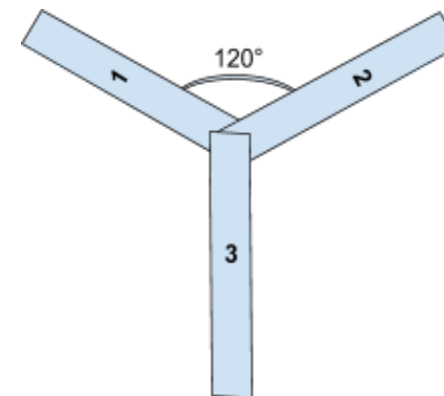

3. Staple last strip straight down from other 2 strips in a Y-shape.

4. Gently fold down the bottom right corner of the 3rd strip at a 45° angle - (*do not need to sharply crease the cardboard..*) This corner fold is what will get your boomerang to act like a boomerang and not like a regular frisbee.

(Feel free to play around with the angle of this corner fold to see which angle works best for your boomerang..)

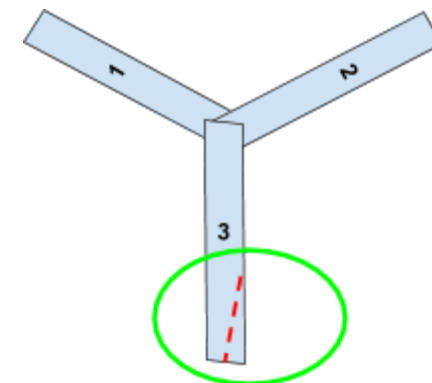

Your boomerang is complete and ready for you to start throwing! Try out different boomerang throwing techniques and see which works best for you!

(*Note: Please always remember to throw your boomerang in a *safe & open* environment and remember that it may take many tries before you get the hang of throwing your boomerang.)

Boomerang Science - (“What Goes Around Comes Back Around...”)

The key to getting a boomerang to return to you is to create a phenomenon known as *gyroscopic precession*, which is what allows for the boomerang to “defy gravity” for longer than a regular object thrown along a parabolic trajectory. Gyroscopic precession refers to the “wobble” that happens when a twisting force (torque) is applied to an already rotating object. This concept can be a bit counterintuitive to understand - (especially since it defies our norms/expectations for how objects moving linearly will behave) - therefore it is highly recommended that you watch the demo shown in this Veritasium video to gain a better visualization for the phenomenon in action...: [Veritasium's Gyroscopic Precession Explanation + Demo](#)

As mentioned earlier, boomerangs are also examples of gyroscopic precession in action. A boomerang will precess due to the fact that the top edge of a boomerang is able to travel faster in comparison to the air it's traveling through. This discrepancy is what gives the spinning boomerang the torque it needs to precess and ultimately get more lift.